



**7-INCH DIGITAL MEDIA STATION**

**iLX-705D**

**HALO9 9-INCH DIGITAL MEDIA STATION**

**iLX-F905D**

**HALO11 11-INCH DIGITAL MEDIA STATION**

**iLX-F115D**

**9-INCH SEPARATE DIGITAL MEDIA STATION**

**i905**

EN

DE

FR

ES

RU

QUICK REFERENCE GUIDE  
KURZANLEITUNG  
GUIDE DE RÉFÉRENCE RAPIDE  
GUÍA DE REFERENCIA RÁPIDA  
КРАТКОЕ СПРАВОЧНОЕ РУКОВОДСТВО



# Contents

WARNING .....	2
CAUTION .....	3
Getting Started .....	4
Apple CarPlay Operation (Optional).....	8
Android Auto™ (Optional).....	8
Radio/RDS Operation .....	9
DAB/DAB+/DMB Operation .....	9
USB Flash drive Operation (Optional).....	10
iPod mode on iPhone (Optional).....	11
Hands-Free Phone Control .....	12
Installation.....	13
Connections.....	18
Specifications .....	21

## IMPORTANT

Please record the serial number of your unit in the space provided below and keep it as a permanent record.

SERIAL NUMBER: \_\_\_\_\_

ISO SERIAL NUMBER: AL \_\_\_\_\_

INSTALLATION DATE: \_\_\_\_\_

INSTALLATION TECHNICIAN: \_\_\_\_\_

PLACE OF PURCHASE: \_\_\_\_\_

For details on all functions, refer to the Owner's Manual published on our website at <https://www.alpine-europe.com/alpine-europe.html> If required, an ALPINE dealer will readily provide you with a print out of the Owner's Manual published on the website.

## WARNING



**This symbol means important instructions. Failure to heed them can result in serious injury or death.**

---

### **INSTALL THE PRODUCT CORRECTLY SO THAT THE DRIVER CANNOT WATCH TV/VIDEO UNLESS THE VEHICLE IS STOPPED AND THE PARKING BRAKE IS APPLIED.**

It is dangerous for the driver to watch TV/Video while driving a vehicle. Installing this product incorrectly enables the driver to watch TV/Video while driving. This may cause a distraction, preventing the driver from looking ahead, thus causing an accident. The driver or other people could be severely injured.

---

### **DO NOT WATCH VIDEO WHILE DRIVING.**

Watching the video may distract the driver from looking ahead of the vehicle and cause an accident.

---

### **DO NOT OPERATE ANY FUNCTION THAT TAKES YOUR ATTENTION AWAY FROM SAFELY DRIVING YOUR VEHICLE.**

Any function that requires your prolonged attention should only be performed after coming to a complete stop. Always stop the vehicle in a safe location before performing these functions. Failure to do so may result in an accident.

---

### **KEEP THE VOLUME AT A LEVEL WHERE YOU CAN STILL HEAR OUTSIDE NOISES WHILE DRIVING.**

Excessive volume levels that obscure sounds such as emergency vehicle sirens or road warning signals (train crossings, etc.) can be dangerous and may result in an accident. LISTENING AT LOUD VOLUME LEVELS IN A CAR MAY ALSO CAUSE HEARING DAMAGE.

---

### **MINIMIZE DISPLAY VIEWING WHILE DRIVING.**

Viewing the display may distract the driver from looking ahead of the vehicle and cause an accident.

---

### **DO NOT DISASSEMBLE OR ALTER.**

Doing so may result in an accident, fire or electric shock.

---

### **USE ONLY IN CARS WITH A 12 VOLT NEGATIVE GROUND.**

(Check with your dealer if you are not sure.) Failure to do so may result in fire, etc.

---

### **KEEP SMALL OBJECTS SUCH AS SCREWS OUT OF THE REACH OF CHILDREN.**

Swallowing them may result in serious injury. If swallowed, consult a physician immediately.

---

### **USE THE CORRECT AMPERE RATING WHEN REPLACING FUSES.**

Failure to do so may result in fire or electric shock.

---

### **DO NOT BLOCK VENTS OR RADIATOR PANELS.**

Doing so may cause heat to build up inside and may result in fire.

---

---

### **USE THIS PRODUCT FOR MOBILE 12V APPLICATIONS.**

Use for other than its designed application may result in fire, electric shock or other injury.

---

### **MAKE THE CORRECT CONNECTIONS.**

Failure to make the proper connections may result in fire or product damage.

---

### **BEFORE WIRING, DISCONNECT THE CABLE FROM THE NEGATIVE BATTERY TERMINAL.**

Failure to do so may result in electric shock or injury due to electrical shorts.

---

### **DO NOT ALLOW CABLES TO BECOME ENTANGLED IN SURROUNDING OBJECTS.**

Arrange wiring and cables in compliance with the manual to prevent obstructions when driving. Cables or wiring that obstruct or hang up on places such as the steering wheel, gear lever, brake pedals, etc. can be extremely hazardous.

---

### **DO NOT SPLICE INTO ELECTRICAL CABLES.**

Never cut away cable insulation to supply power to other equipment. Doing so will exceed the current carrying capacity of the wire and result in fire or electric shock.

---

### **DO NOT DAMAGE PIPE OR WIRING WHEN DRILLING HOLES.**

When drilling holes in the chassis for installation, take precautions so as not to contact, damage or obstruct pipes, fuel lines, tanks or electrical wiring. Failure to take such precautions may result in fire.

---

### **DO NOT USE BOLTS OR NUTS IN THE BRAKE OR STEERING SYSTEMS TO MAKE GROUND CONNECTIONS.**

Bolts or nuts used for the brake or steering systems (or any other safety-related system), or tanks should NEVER be used for installations or ground connections. Using such parts could disable control of the vehicle and cause fire etc.

---

### **DO NOT INSTALL IN LOCATIONS WHICH MIGHT HINDER VEHICLE OPERATION, SUCH AS THE STEERING WHEEL OR SHIFT LEVER.**

Doing so may obstruct forward vision or hamper movement etc. and results in serious accident.

---

**CAUTION**

**This symbol means important instructions. Failure to heed them can result in injury or material property damage.**

---

**HALT USE IMMEDIATELY IF A PROBLEM APPEARS.**

Failure to do so may cause personal injury or damage to the product. Return it to your authorized Alpine dealer or the nearest Alpine Service Center for repairing.

---

**HAVE THE WIRING AND INSTALLATION DONE BY EXPERTS.**

The wiring and installation of this unit requires special technical skill and experience. To ensure safety, always contact the dealer where you purchased this product to have the work done.

---

**USE SPECIFIED ACCESSORY PARTS AND INSTALL THEM SECURELY.**

Be sure to use only the specified accessory parts. Use of other than designated parts may damage this unit internally or may not securely install the unit in place. This may cause parts to become loose resulting in hazards or product failure.

---

**ARRANGE THE WIRING SO IT IS NOT CRIMPED OR PINCHED BY A SHARP METAL EDGE.**

Route the cables and wiring away from moving parts (like the seat rails) or sharp or pointed edges. This will prevent crimping and damage to the wiring. If wiring passes through a hole in metal, use a rubber grommet to prevent the wire's insulation from being cut by the metal edge of the hole.

---

**DO NOT INSTALL IN LOCATIONS WITH HIGH MOISTURE OR DUST.**

Avoid installing the unit in locations with high incidence of moisture or dust. Moisture or dust that penetrates into this unit may result in product failure.

---

## Getting Started

### Controls Position

The screen design used in the Quick Reference Guide may differ from the actual screen.

#### ■ iLX-705D

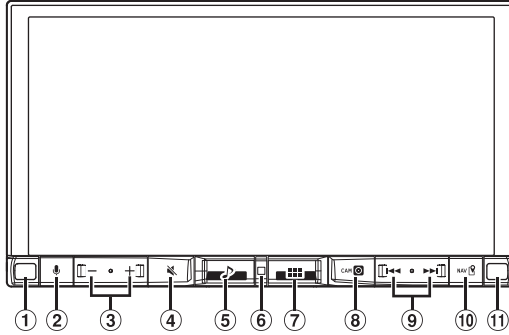

#### ■ iLX-F905D/iLX-F115D

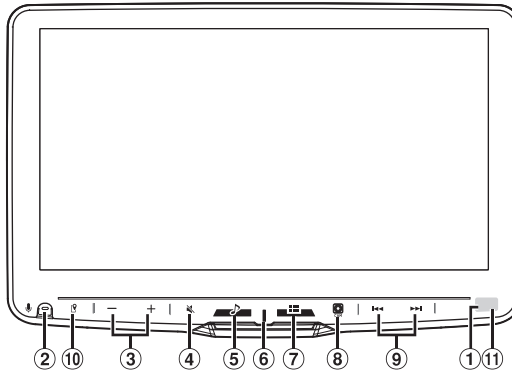

- ① **Dimmer Sensor**  
Sense the brightness of the car interior.
- ② **🎤 button**  
Activate Siri function or voice recognition mode while Apple CarPlay or Android Auto is connected.
- ③ **— / + (DOWN/UP) button**  
Adjusts the volume.
- ④ **🔇 (MUTE) button**  
Activates/deactivates MUTE mode.  
Press and hold this button for at least 2 seconds to turn off the screen/button illumination.
- ⑤ **🎵 (Audio) button**  
Displays the Audio playback screen.  
Audio sources can be switched while the Audio playback screen is displayed.
- ⑥ **Power indicator**
- ⑦ **🏠 (HOME) button**  
Activates the HOME screen.  
The Sound Setup screen is displayed while the HOME screen is displayed.  
Press and hold this button for at least 2 seconds to turn the power off.
- ⑧ **📷 (CAM) button**  
Displays the image of Camera2 (Front/Side/Other) or Camera1 (Rear).  
Press for 1 second or more to return to the previous screen.
- ⑨ **⏮ / ⏭ button**  
Press to seek up/down a station in radio mode or up/down a track, etc., in other audio/visual sources.
- ⑩ **📍 (MAP) button**  
Displays the map screen for Apple CarPlay / Android Auto when Apple CarPlay or Android Auto is connected.
- ⑪ **Remote Sensor**  
Point the remote control transmitter towards the remote sensor within a range of 2 meters.

## Turning Power On or Off

### 1 Turn the ignition key to the ACC or ON position.

The system is turned on.

- When using the system for the first time, the HOME screen is displayed.



CAUTION (iLX-F905D/iLX-F115D only)

**To adjust the display angle, hold the center of the top and bottom of the display to move it.**

**To protect the display, do not hold the left and right ends to move it.**

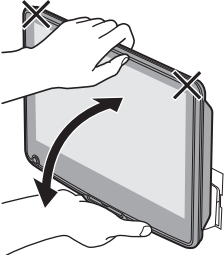

## About the HOME Screen

Select the audio source on the HOME screen to perform various settings and operations of the function.

### 1 Press the (HOME) button.

The HOME screen is displayed.

### ■ Normal mode screen example

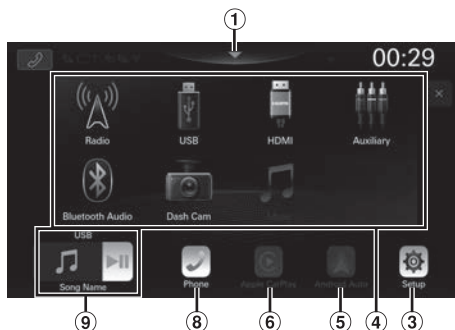

### ■ Enhanced Text mode screen example

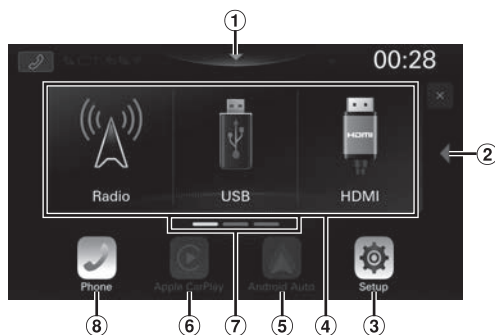

① **Touch to display the Sound Setup screen.**

② **Touch to change the page.**

Pages can also be changed by swiping the HOME screen horizontally with your finger.

③ **Setup button**

Displays the Setup screen.

④ **Audio source select area**

Touch your desired source icon to change the audio source.

⑤ **Android Auto button**

Displays the Android Auto screen, high light displayed when an Android Smartphone installed Android Auto App is connected.

⑥ **Apple CarPlay button**

Displays the Apple CarPlay screen, high light displayed when Apple CarPlay is turned on and an iPhone 6s or later is connected.



⑦ **HOME screen navigation**

⑧ **Phone button**

Displays the Phone menu screen.

The Device List screen is displayed when a Hands-free Phone, Apple CarPlay or Android Auto device is not connected.

⑨ **Thumbnail window for the current source**

Source name, artwork and title information are displayed. Touch  to display the source screen. Touch  to play/pause a track or video.



## Setting the Home Screen Type

---

The Home screen can be changed to the Enhanced Text mode.

### 1 Press the (HOME) button.

The HOME screen is displayed.

### 2 Touch [Setup].

The Setup screen is displayed.

### 3 Touch [System].

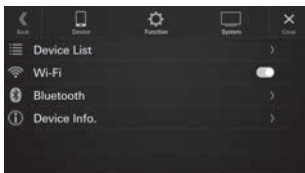

### 4 Touch [Home Screen Type].

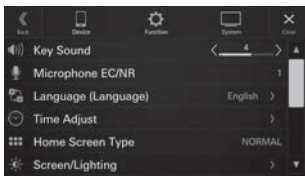

### 5 Touch [Normal] or [Enhanced Text].

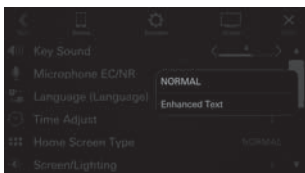

## Apple CarPlay Operation (Optional)

Apple CarPlay is a smarter, safer way to use your iPhone in the car. Apple CarPlay takes the things you want to do with your iPhone while driving and puts them right on this unit. You can get directions, make calls, send and receive messages, and listen to music, all in a way that allows you to stay focused on the road.

### 1 Press the (HOME) button.

The HOME screen is displayed.

### 2 Touch [Apple CarPlay].

The Apple CarPlay screen is displayed.

- Refer to "Apple CarPlay" in the Owner's Manual for information on how to operate Apple CarPlay.

## Android Auto™ (Optional)

Android Auto brings your favorite smartphone apps into one place, making it easier for drivers to access their favorite navigation, media, and communication apps on the road while minimizing the distractions. Talk to Google on Android Auto™ and get things done with your voice so you can keep your eyes on the road and hands on the wheel. Easily send messages, get directions, control media and more. Just short-press or long-press the voice control button on your steering wheel.

### 1 Press the (HOME) button.

The HOME screen is displayed.

### 2 Touch [Android Auto].

The Android Auto screen is displayed.

- Refer to "Android Auto" in the Owner's Manual for information on how to operate Android Auto.

## Radio/RDS Operation

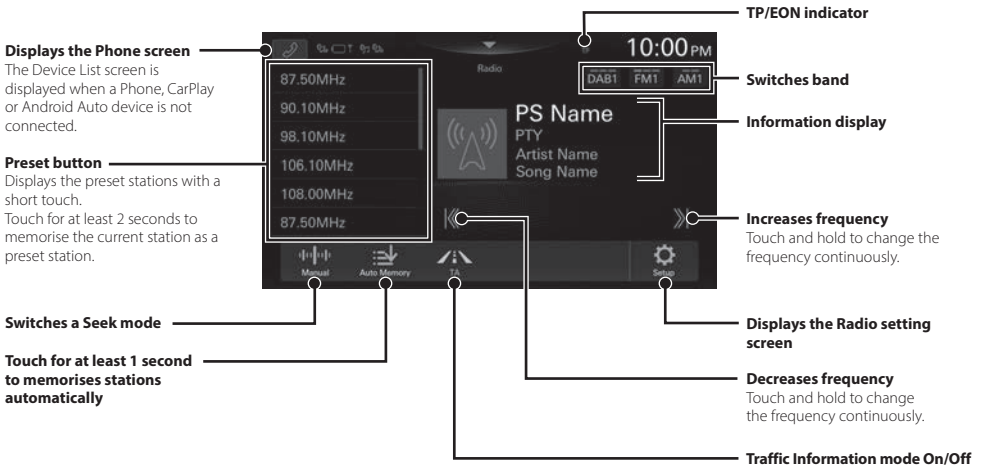

- The patterns of some keys in the Quick Reference Guide may differ from the actual screen.

## DAB/DAB+/DMB Operation

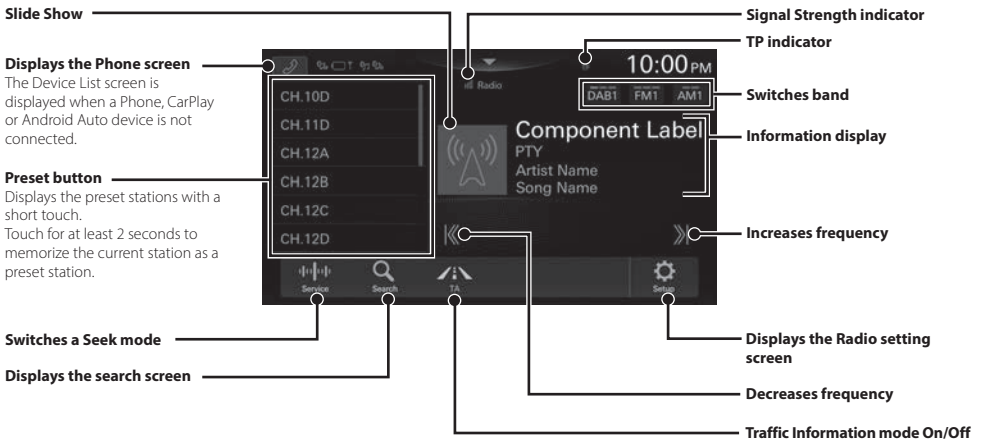

- The patterns of some keys in the Quick Reference Guide may differ from the actual screen.

## USB Flash drive Operation (Optional)

You can play back music files (MP3/WMA/AAC/FLAC/WAV/APE) and video files (MP4/MOV/FLV/MKV) stored in a USB flash drive on the internal player of this system.

### USB Audio main screen example

#### Displays the Phone screen

The Device List screen is displayed when a Phone, CarPlay or Android Auto device is not connected.

**Finds the beginning of the current file/Finds a previous file within 3 seconds after playback starts/ Fast-reverses when touched for at least 1 second**

#### Artwork display

#### Pause and Play

#### Repeat playback

#### Shuffle play

#### Time Bar (Elapsed time/Total time for playing)

#### Information display

#### Switches to USB Video mode

**Finds the beginning of next chapter/Fast-forwards when touched for at least 1 second**

#### Next song information display

#### Hi-Res icon display

Displays the USB Setup Menu screen

Current track number/  
Total track number

Displays the search screen

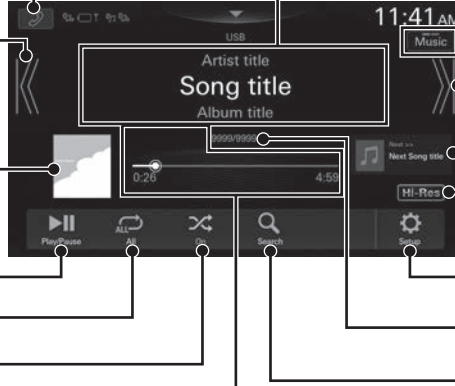

- The patterns of some keys in the Quick Reference Guide may differ from the actual screen.

### Searching for a Music File

For example: Searching by Artist name

**1** Touch [Q (Search)] during playback.

**2** Touch [Artists].

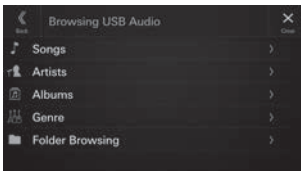

**3** Touch the desired artist's name.

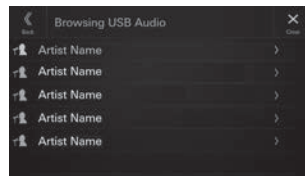

**4** Touch the desired album's name.

**5** Touch the desired song's name.

The selected song is played back.

## iPod mode on iPhone (Optional)

A separately sold Lightning to USB cable is required depending on the type of iPhone.

### Displays the Phone screen

The Device List screen is displayed when a Phone, CarPlay or Android Auto device is not connected.

**Finds the beginning of the current file/Finds a previous file within 3 seconds after playback starts/Fast-reverses when touched for at least 1 second**

### Artwork display

### Pause and Play

### Repeat playback

### Shuffle play

### Time Bar (Elapsed time/Total time for playing)

### Information display

**Finds the beginning of the next file/Fast-forwards when touched for at least 1 second**

### Next song information display

**Displays the iPod Setup Menu screen**

**Current track number/ Total track number**

**Displays the search screen**

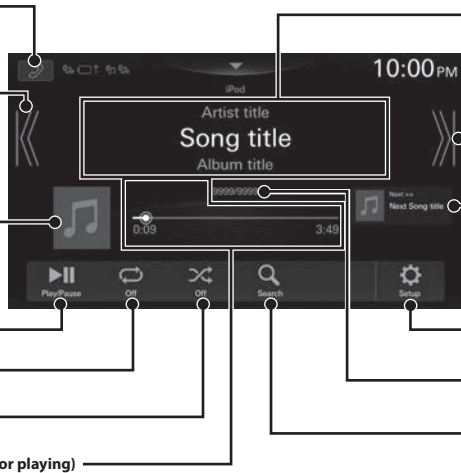

- This unit supports iPhone (iPhone 6s or later) only. For using music playback only, set the "Apple CarPlay" setting to "Off" before connecting with your iPhone.
- The patterns of some keys in the Quick Reference Guide may differ from the actual screen.

## Searching for a Music File

For example: Searching by Artist name

**1** Touch [Q (Search)] during playback.

**2** Touch [Artists].

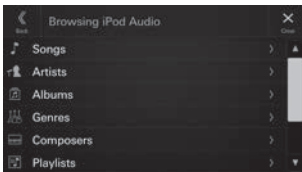

**3** Touch the desired artist's name.

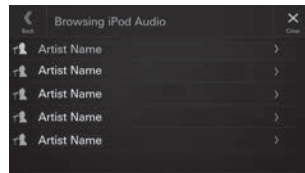

**4** Touch the desired album's name.

**5** Touch the desired song's name.

The selected song is played back.

## Hands-Free Phone Control

The unit can connect with up to two hands-free phones.

### How to connect to a Bluetooth compatible device (Pairing)

To display the Setup HOME screen:

- Bring your vehicle to a complete stop at a safe location. Engage the parking brake.

**1 Touch [Setup] on the HOME screen.**

**2 Touch [Device].**

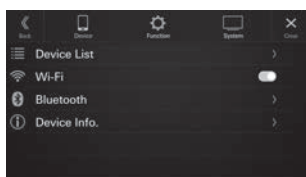

**3 Touch [Device List].**

**4 Touch [Add New Device] to search for a new device.**

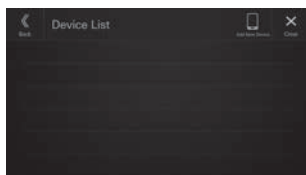

The Select Function screen is displayed.

**5 Select the function of the connecting device on the Select Function screen, and touch [OK].**

A check mark is displayed for the selected function.

- Hands Free1: The device is used as the first hands-free phone.
- Hands Free2: The device is used as the second hands-free phone.
- Bluetooth Audio: The device is used as an Bluetooth Audio device.
- Apple CarPlay\*: The device is used as Apple CarPlay.

\* If you want to use Apple CarPlay mode without displaying [Apple CarPlay] on the Select Function screen, select [Hands Free1] or [Hands Free2] to connect your device.

**6 When a code is displayed on the device, check that the code is the same as the one on the screen of the unit, and touch [Yes].**

**7 When the device connection is complete, a message appears and the device returns to normal mode.**

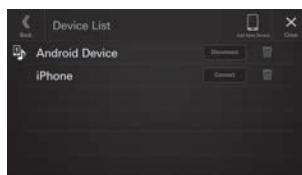

- You can register up to 10 Bluetooth compatible mobile phones.

### Answering a Call

**1 An incoming call triggers the ringtone and an incoming call display.**

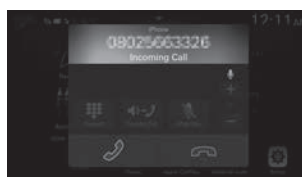

**2 Touch [Answer].**

The call starts.

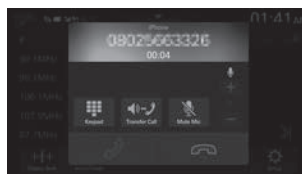

### Hanging up the Telephone

**1 Touch [End Call].**

The call finishes.

# Installation

## Note on installation

- Install at an angle between horizontal and 30°. Note that installing at an angle outside of this range will result in a loss of performance and possible damage.

### <iLX-705D>

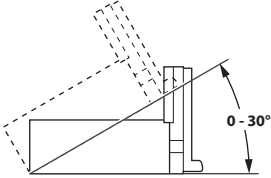

### <iLX-F905D/iLX-F115D>

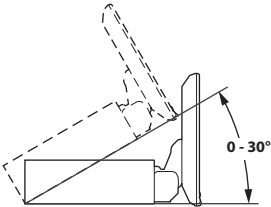

- Do not block the unit's heat sink, which would prevent air circulation. If blocked, heat will accumulate inside the unit and may cause a fire.

Air ventilation hole

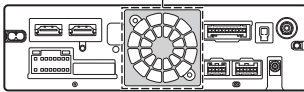

Rear of the Unit

- When installing the display unit and main unit, do not touch the connectors with your hands. (iLX-F905D/iLX-F115D only)

### <Display unit>

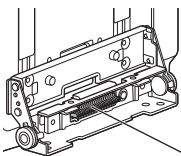

### <Main unit>

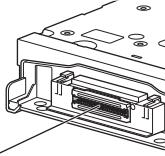

Connectors

## Mounting the Microphone

For safe use, make sure of the following:

- Location is stable and firm.
- Driver's view and operations are not obstructed.
- Microphone is located where the driver's voice can be easily picked up.

When you speak into the microphone, you should not have to change your driving posture. This may cause a distraction, taking your attention away from safely driving your vehicle. Carefully consider direction and distance while mounting the microphone. Confirm that the driver's voice can be easily picked up at the selected location.

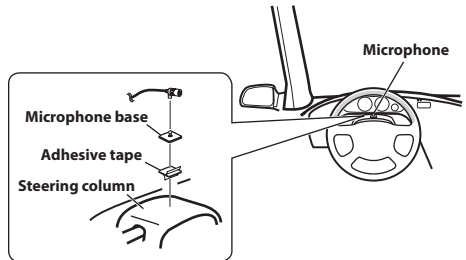

## Mounting the GPS Antenna inside the vehicle

- Clean the mounting location.
- Put on the GPS Antenna mounting plate.
- Mount the GPS Antenna.

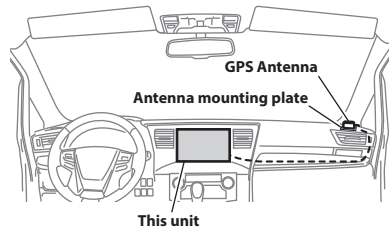

- Do not mount the GPS Antenna inside the centre console.
  - Mount the GPS Antenna on a flat plane of the dash board or rear tray.
  - Make sure the GPS Antenna is not covered (obstructed) by any metallic surface or object.

- If the GPS Antenna is mounted near the unit, the reception becomes poor, and the location of your vehicle may not be displayed correctly.
  - Mount the GPS Antenna far away enough from the unit.
  - Bundle the GPS Antenna cable away from the rear of the unit.
- Some thermal reflection type or thermal absorption type glass may interrupt high frequency waves. If reception is poor with the antenna installed inside the car, try to mount the antenna outside the car.

## Note on using HDMI Connection Cables

When using HDMI connection cables, secure the cables to the HDMI Terminals with the supplied HDMI Fixation Bracket.

- 1 **Secure the HDMI Fixation Bracket with the screw (A).**

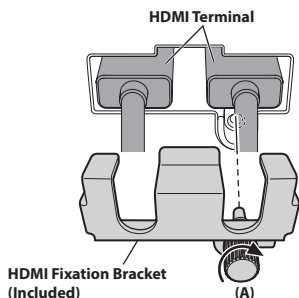

## Adjusting the display position (iLX-F905D/iLX-F115D)

Depending on the vehicle, the front-back display position differs. To adjust the front-back position, set the slider to the forward position.

Default setting: Back position

### Front-back position

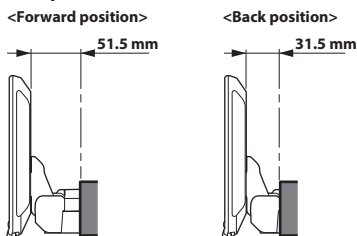

- 1 **Remove 4 hexagon bolts from both sides of the unit.**

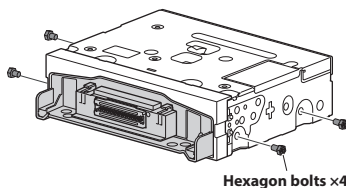

- 2 **Pull out the slider to the forward position. (To return the slider to the back position, push it in.)**

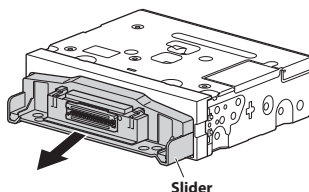

- 3 **Install 4 hexagon bolts to secure the slider.**

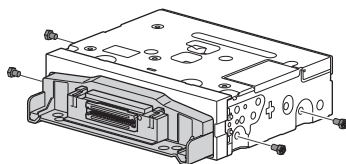

## Installing the Unit (iLX-705D)

- 1 **Mount the original mounting bracket to the unit using the supplied screws.**

If you do not have the original mounting bracket, mount the Double din KIT\* (provided with the side mounting bracket), etc. to the main unit.

\* Sold separately.

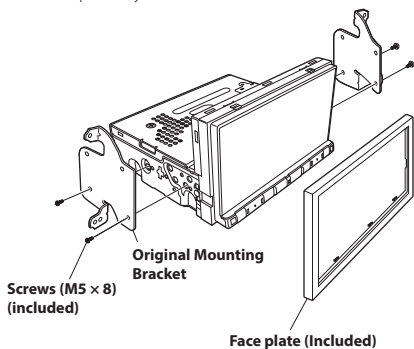



**2** Connect all other leads of the unit according to details described in the "Connections" (page 18).

**3** Mounting the unit in a car.

- Fix the cables carefully. Do not damage them by tucking them into movable parts, such as a seat rail, or by locating them against sharp or pointed edges.

## Installing the Unit (iLX-F905D/ iLX-F115D)

**1** Mount the original mounting bracket to the main unit using the supplied screws.

- If you do not have the original mounting bracket, mount the Double din KIT\* (provided with the side mounting bracket), etc. to the main unit.

\* Sold separately.

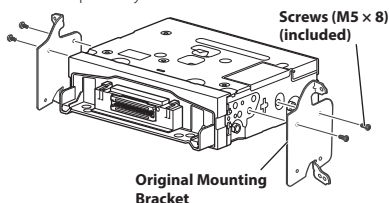

**2** Connect all other leads of the main unit according to details described in the "Connections" (page 18).

**3** Mount the unit in a car.

- Fix the cables carefully. Do not damage them by mounting them into movable parts, such as the seat rail, or by locating them against sharp or pointed edges.

## Adjust the up-down position of the Display unit (iLX-F905D/iLX-F115D)

Adjust the up-down position of the display according to the mounting position on the vehicle before mounting the display unit.

Default setting: 0 mm

**1** Remove the 4 screws on the rear of the display unit, then adjust the up-down position.

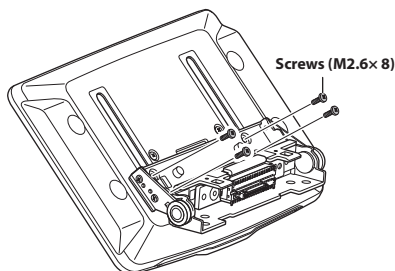

**2** Attach the Sheet Rear in a position that aligns with the up-down position of the display unit.

Sheet Rear (Included)	up-down position
2x50 mm:	for up-down position 0 mm or -60mm
2x35 mm:	for up-down position -15 mm or -45mm
2x20 mm:	for up-down position -30 mm

**0 mm**

Sheet Rear (2x50 mm)

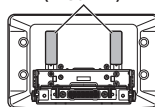

**-15 mm**

Sheet Rear (2x35 mm)

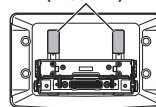

**-30 mm**

Sheet Rear (2x20 mm)

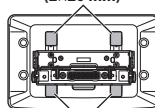

**-45 mm**

Sheet Rear (2x35 mm)

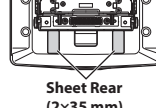

Sheet Rear (2x20 mm)

-60 mm

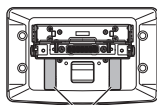

Sheet Rear  
(2×50 mm)

- 3** Attach the Cover Rear to the rear of the display unit using 2 screws (M2.6×6). Secure the screws, then attach the Sheet caps.

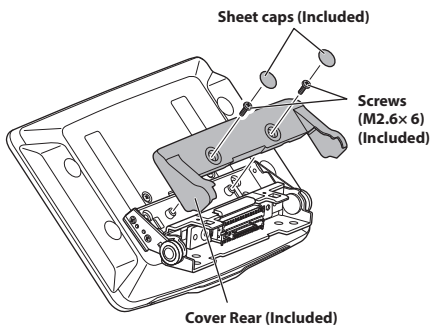

## Install the display unit (iLX-F905D/ iLX-F115D)

- 1** Fix the Display unit to the slider of the main unit using 4 screws (M5×8).

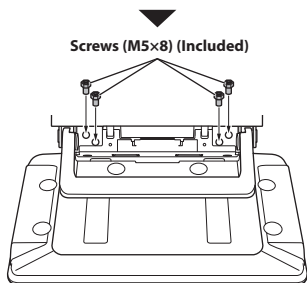
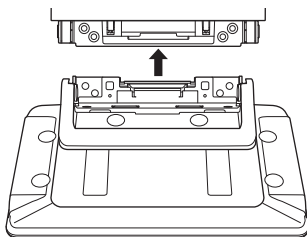

## CAUTION

Do not adjust the display angle when the display unit is not fixed to the slider of the main unit using 4 screws (M5×8). Doing so may not turn power on.

- 2** Mount the Power Plate.

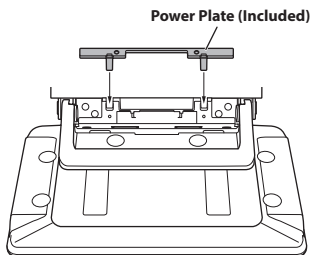

- If the Power Plate is not mounted, the display unit may not be turned power on. Make sure to mount it.

- 3** Mount the Cover Hinge using 2 screws (M3×4). Secure the screws, then attach the Sheet Hinges.

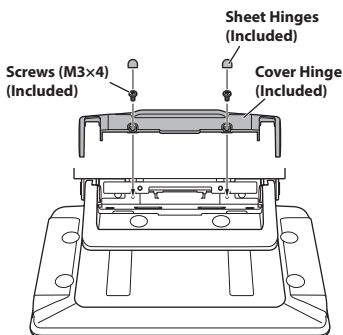

## Connection Diagram of SPST Switch (sold separately)

(If the ACC power supply is not available)

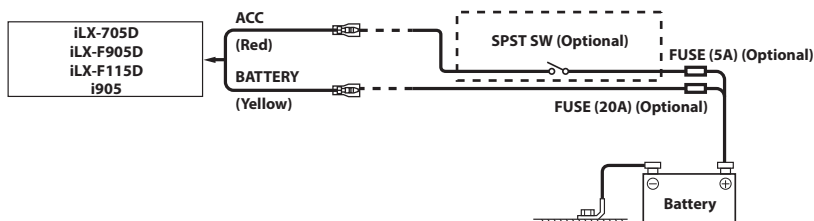

- If your vehicle has no ACC power supply, add an SPST (Single-Pole, Single-Throw) switch (sold separately) and fuse (sold separately).
- The diagram and the fuse amperage shown above are in the case when the unit is used individually.
- If the switched power (ignition) lead of the unit is connected directly to the positive (+) post of the vehicle's battery, the unit draws some current (several hundred milliamperes) even when its switch is placed in the OFF position, and the battery may be discharged.

# Connections

## Connection 1

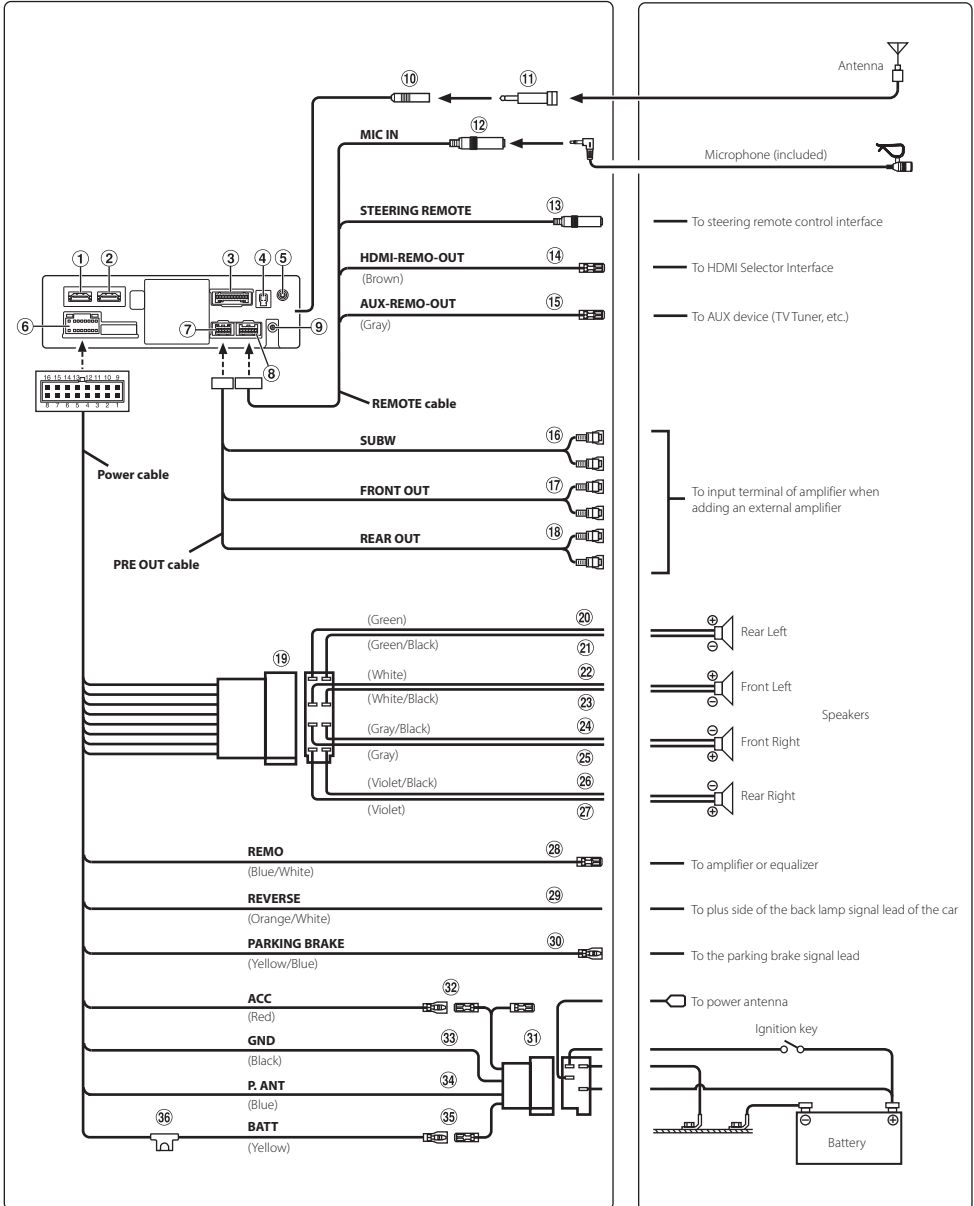

## Connection 2

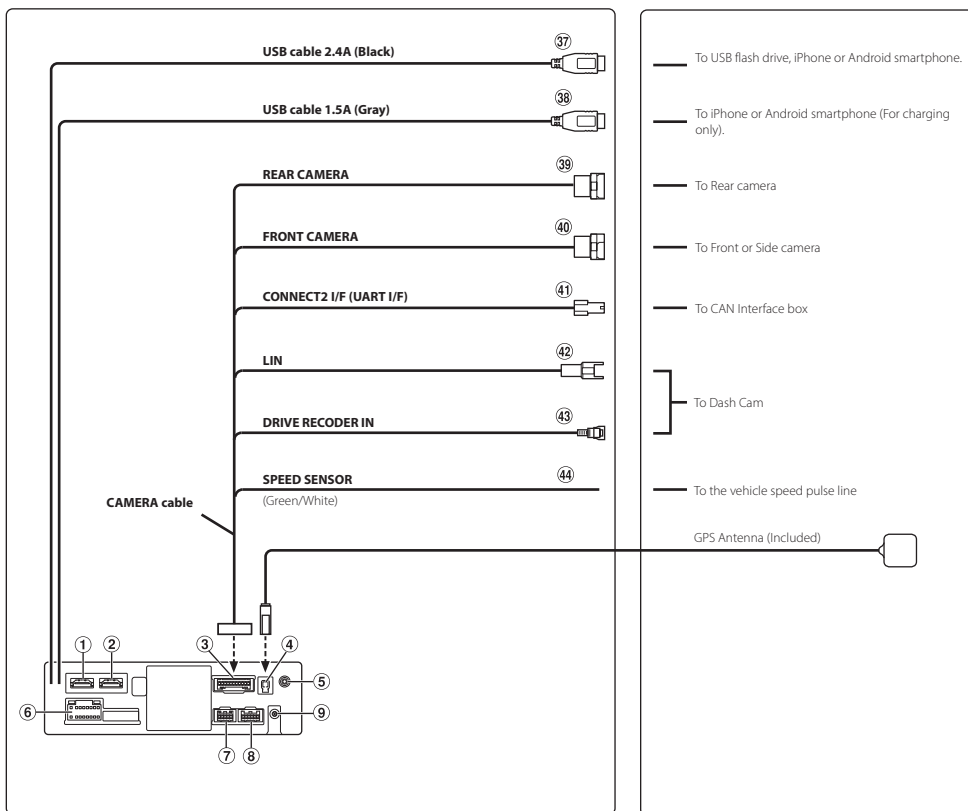

- ① **HDMI Input Connector**
- ② **HDMI Output Connector**
- ③ **CAMERA Connector**
- ④ **GPS Antenna Receptacle**  
Connect to GPS antenna (Included).
- ⑤ **AUX Input Connector**  
Input lead for AUX audio signal.
- ⑥ **Power Supply Connector**
- ⑦ **PRE OUT Connector**
- ⑧ **REM Connector**
- ⑨ **DAB Antenna Connector**  
To DAB Antenna (sold separately).
- ⑩ **Radio Antenna Receptacle**
- ⑪ **ISO/JASO Antenna Adapter (sold separately)**  
ISO/JASO Antenna Adapter may be required, depending on the vehicle.
- ⑫ **MIC Input Connector**  
To microphone (included).
- ⑬ **Steering Remote Control Interface Connector**  
To steering remote control interface.  
For details about connections, consult your nearest Alpine dealer.
- ⑭ **HDMI-REM-OUT Lead (Brown)**  
Connect this lead to the remote input lead of your HDMI Selector Interface.
- ⑮ **AUX-REM-OUT Lead (Gray)**  
Connect this lead to the remote input lead of your AUX device.

- 16 Subwoofer RCA Connectors**  
RED is right and WHITE is left.
- 17 Front Output RCA Connectors**  
Can be used as Front Output RCA Connectors. RED is right and WHITE is left.
- 18 Rear Output RCA Connectors**  
Can be used as Rear Output RCA Connectors. RED is right and WHITE is left.
- 19 ISO Connector (Speaker Output)**
- 20 Left Rear (+) Speaker Output Lead (Green)**
- 21 Left Rear (-) Speaker Output Lead (Green/Black)**
- 22 Left Front (+) Speaker Output Lead (White)**
- 23 Left Front (-) Speaker Output Lead (White/Black)**
- 24 Right Front (-) Speaker Output Lead (Gray/Black)**
- 25 Right Front (+) Speaker Output Lead (Gray)**
- 26 Right Rear (-) Speaker Output Lead (Violet/Black)**
- 27 Right Rear (+) Speaker Output Lead (Violet)**
- 28 Remote Turn-On Lead (Blue/White)**  
Connect this lead to the remote turn-on lead of your amplifier or signal processor.
- 29 Reverse Lead (Orange/White)**
- 30 Parking Brake Lead (Yellow/Blue)**  
Connect this lead to the power supply side of parking brake switch to transmit the parking brake status signals to the unit.
- 31 ISO Power Supply Connector**
- 32 Switched Power Lead (Ignition) (Red)**  
Connect this lead to an open terminal on the vehicle's fuse box or another unused power source that provides (+) 12V only when the ignition is turned on or in the accessory position.
- 33 Ground Lead (Black)**  
Connect this lead to a good chassis ground on the vehicle.  
Make sure the connection is made to bare metal and is securely fastened using the sheet metal screw provided.
- 34 Power Antenna Lead (Blue)**  
Connect this lead to the +B terminal of your power antenna, if applicable.  
• This lead should be used only for controlling the vehicle's power antenna. Do not use this lead to turn on an amplifier or a signal processor, etc.
- 35 Battery Lead (Yellow)**  
Connect this lead to the positive (+) post of the vehicle's battery.
- 36 Fuse Holder (15A)**
- 37 USB Connector (2.4A)**  
To USB flash drive, iPhone or Android smartphone.
- 38 USB Connector (1.5A)**  
To iPhone or Android smartphone (For charging only).
- 39 REAR CAMERA Input Connector**  
Use when connecting a rear camera.
- 40 FRONT CAMERA Input Connector**  
Use when connecting a front camera or side camera.
- 41 Connect2 (UART) Connector**  
To Interface Box.
- 42 LIN Connector**  
Connect this lead to the LIN connector of the Dash Cam.
- 43 Drive Recorder Input Connector**  
Input lead for Dash Cam video signal.
- 44 Speed Sensor Lead (Green/White)**  
Improper connection of the speed pulse line may cause important safety features of the vehicle to fail (such as the brakes or air bags). Such failures may result in an accident and loss of life. We strongly recommend that the installation be performed by a trained, authorized Alpine dealer.

# Specifications

## MONITOR SECTION

Screen Size	7" (iLX-705D) 9" (iLX-F905D) 11" (iLX-F115D) 9" (i905)
Operation System	TFT active matrix
Number of Picture Elements	2,764,800 pcs. (1280 × 720 × RGB)
Effective Number of Picture Elements	99% or more
Color system	NTSC / PAL
Illumination System	LED

## FM TUNER SECTION

Tuning Range	87.5 – 108.0 MHz
Mono Usable Sensitivity	8.1 dBf (0.7 $\mu$ V/75 ohms)
50 dB Quieting Sensitivity	12 dBf (1.1 $\mu$ V/75 ohms)
Alternate Channel Selectivity	80 dB
Signal-to-Noise Ratio	65 dB
Stereo Separation	35 dB

## AM TUNER SECTION

Tuning Range	531 – 1,602 kHz
Usable Sensitivity	25.1 $\mu$ V/28 dBf

## DAB SECTION

Tuning Range	174 – 240 MHz
Usable Sensitivity	-100 dBm
Signal-to-Noise Ratio	90 dB

## USB1 SECTION

USB requirements	USB 2.0
Max. Power Consumption	2,400 mA
USB Class	USB (Mass Storage Class)
File System	FAT16 / 32, exFAT
Number of Channels	2-Channels (Stereo)
Frequency Response*1	5 – 40,000 Hz ( $\pm$ 1 dB)
Total Harmonic Distortion	0.005% (at 1 kHz)
Dynamic Range	95 dB (at 1 kHz)
Signal-to-Noise Ratio	95 dB
Channel Separation	90 dB (at 1 kHz)

\*1 Frequency response may differ depending on the encoder software/bit rate.

## USB2 SECTION

Max. Power Consumption	1,500 mA (CDP Support)
USB Class	Charge only

## HDMI SECTION

Input Format	720p / 480p / VGA
Output Format	720p / 480p

## Bluetooth SECTION

Bluetooth Specification	Bluetooth V4.2 (2,402 - 2,480 MHz)
Output Power	+4.0 dBm/2.51 mW Ave. (Power class 2)

Profile	HFP (Hands-Free Profile) OPP (Object Push Profile) PBAP (Phone Book Access Profile) SPP (Serial Port Profile) A2DP (Advanced Audio Distribution Profile) AVRCP (Audio/Video Remote Control Profile)
---------	--

## GPS SECTION

Reception Frequency	1575.42 + / - 1.023 MHz
Reception sensitivity (Search)	-136 dB max.

## Wi-Fi SECTION

Frequency Ranges	IEEE 802.11 b/g/n (2.4 GHz)
Channels	1 – 13 ch (2.4 GHz)
Security Protocols	WPA3 / WPA2-PSK (TKIP, AES)

## GENERAL

Power Requirement	14.4 V DC (11–16 V allowable)
Operating temperature	-20°C to + 60°C
Power Output	50 W × 4
Maximum Current Consumption	15 A
Audio output level	
Preout (Front, Rear):	4V/10k ohms (max.)
Preout (Subwoofer):	4V/10k ohms (max.)
Weight	1.4 kg (iLX-705D) 2.3 kg (iLX-F905D) 2.6 kg (iLX-F115D)

## CHASSIS SIZE

	iLX-705D	iLX-F905D	iLX-F115D	i905
Width	178 mm	178 mm	178 mm	178 mm
Height	50 mm	50 mm	50 mm	50 mm
Depth	149.6 mm	149.6 mm	149.6 mm	142 mm

## DISPLAY SIZE

	iLX-705D	iLX-F905D	iLX-F115D	i905
Width	171 mm	232.5 mm	268.9 mm	214.7 mm
Height	96 mm	151.1 mm	178 mm	136.6 mm
Depth	17.7 mm	54.7 mm	54.7 mm	29.9 mm

- Due to continuous product improvement, specifications and design are subject to change without notice.
- The LCD panel is manufactured using an extremely high precision manufacturing technology. Its effective pixel ratio is over 99.99%. This means that there is a possibility that 0.01% of the pixels could be either always ON or OFF.

- Windows Media, and the Windows logo are trademarks, or registered trademarks of Microsoft Corporation in the United States and/or other countries.
- Apple, iPhone, iPod, Lightning and Siri are trademarks of Apple Inc., registered in the U.S. and other countries. App Store is a service mark of Apple Inc.
- Use of the Made for Apple and Works with Apple badges means that an accessory has been designed to connect specifically to the Apple product(s) identified in the Made for Apple badge and to work specifically with the technology identified in the Works with Apple badge, and has been certified by the developer to meet Apple performance standards. Apple is not responsible for the operation of this device or its compliance with safety and regulatory standards. Please note that the use of this accessory with an Apple product may affect wireless performance.
- Use of the Apple CarPlay logo means that a vehicle user interface meets Apple performance standards. Apple is not responsible for the operation of this vehicle or its compliance with safety and regulatory standards. Please note that the use of this product with iPhone may affect wireless performance.
- Google, Android, Google Play and Android Auto are trademarks of Google LLC.  
To use Android Auto on your car display, you'll need an Android phone running Android 6.0 or higher, an active data plan, and the Android Auto app.
- The terms HDMI and HDMI High-Definition Multimedia Interface, and the HDMI Logo are trademarks or registered trademarks of HDMI Licensing, LLC in the United States and other countries.
- The Bluetooth® word mark and logos are registered trademarks owned by the Bluetooth SIG, Inc. and any use of such marks by ALPS ALPINE CO., LTD. is under license.
- The Wi-Fi CERTIFIED™ Logo is a registered trademark of Wi-Fi Alliance®.
- LDAC and LDAC logo are trademarks of Sony Corporation.
- The product with this logo is conformed to High-Resolution Audio standard defined by Japan Audio Society. This logo is used under license from Japan Audio Society.

Made for iPhone SE (2nd generation), iPhone 11 Pro Max, iPhone 11 Pro, iPhone 11, iPhone XS Max, iPhone XS, iPhone XR, iPhone X, iPhone 8 Plus, iPhone 8, iPhone 7 Plus, iPhone 7, iPhone SE, iPhone 6s Plus, iPhone 6s.



## SIMPLIFIED EU DECLARATION OF CONFORMITY

Hereby, ALPS ALPINE EUROPE GmbH (<https://www.alpine.de/>) declares that the radio equipment type ILX-705D/iLX-F905D/iLX-F115D/i905 is in compliance with Directive 2014/53/EU.

The full text of the EU declaration of conformity is available at the following internet address:

<http://www.alpine.com/e/research/doc/>

Compliant with UNECE Regulation 10 (E-Mark)



Hereby, ALPS ALPINE EUROPE GmbH (<https://www.alpine.co.uk/>) declares that the radio equipment type ILX-705D/iLX-F905D/iLX-F115D/i905 is in compliance with Radio Equipment Regulations 2017.

The full text of the declaration of conformity is available at the following internet address:

<http://www.alpine.com/e/research/doc/>



[EN] English	Hereby, ALPS ALPINE EUROPE GmbH declares that the radio equipment type ILX-705D/iLX-F905D/iLX-F115D/i905 is in compliance with Directive 2014/53/EU. The full text of the EU declaration of conformity is available at the following internet address: <a href="http://www.alpine.com/e/research/doc/">http://www.alpine.com/e/research/doc/</a>
[BG] Bulgarian	С настоящото ALPS ALPINE EUROPE GmbH декларира, че този тип радиос ъоръжение ILX-705D/iLX-F905D/iLX-F115D/i905 е в съответствие с Директива 2014/53/ЕС. Цялостният текст на ЕС декларацията за съответствие може да се намери на следния интернет адрес: <a href="http://www.alpine.com/e/research/doc/">http://www.alpine.com/e/research/doc/</a>
[CZ] Czech	Tímto ALPS ALPINE EUROPE GmbH prohlašuje, že typ rádiového zařízení ILX-705D/iLX-F905D/iLX-F115D/i905 je v souladu se směrnicí 2014/53/EU. Úplné znění EU prohlášení o shodě je k dispozici na této internetové adrese: <a href="http://www.alpine.com/e/research/doc/">http://www.alpine.com/e/research/doc/</a>
[DA] Danish	Hermed erklærer ALPS ALPINE EUROPE GmbH, at radioudstyrstypen ILX-705D/iLX-F905D/iLX-F115D/i905 er i overensstemmelse med direktiv 2014/53/EU. EU-overensstemmelseserklæringens fulde tekst kan findes på følgende internetadresse: <a href="http://www.alpine.com/e/research/doc/">http://www.alpine.com/e/research/doc/</a>
[DE] German	Hiermit erklärt ALPS ALPINE EUROPE GmbH, dass der Funkanlagentyp ILX-705D/iLX-F905D/iLX-F115D/i905 der Richtlinie 2014/53/EU entspricht. Der vollständige Text der EU-Konformitätserklärung ist unter der folgenden Internetadresse verfügbar: <a href="http://www.alpine.com/e/research/doc/">http://www.alpine.com/e/research/doc/</a>
[EL] Greek	Με την παρούσα ο/η ALPS ALPINE EUROPE GmbH, δηλώνει ότι ο ραδιοεξοπλισμός ILX-705D/iLX-F905D/iLX-F115D/i905 πληροί την οδηγία 2014/53/ΕΕ. Το πλήρες κείμενο της δήλωσης συμμόρφωσης ΕΕ διατίθεται στην ακόλουθη ιστοσελίδα στο διαδίκτυο: <a href="http://www.alpine.com/e/research/doc/">http://www.alpine.com/e/research/doc/</a>
[ES] Spanish	Por la presente, ALPS ALPINE EUROPE GmbH declara que el tipo de equiporadioeléctrico ILX-705D/iLX-F905D/iLX-F115D/i905 es conforme con la Directiva 2014/53/UE. El texto completo de la declaración UE de conformidad está disponible en la dirección Internet siguiente: <a href="http://www.alpine.com/e/research/doc/">http://www.alpine.com/e/research/doc/</a>
[ET] Estonian	Käesolevaga deklareerib ALPS ALPINE EUROPE GmbH et käesolev raadioseadme tüüp ILX-705D/iLX-F905D/iLX-F115D/i905 vastab direktiivi 2014/53/EL nõuetele. Eli vastavusdeklaratsiooni täielik tekst on kättesaadav järgmisel internetiaadressil: <a href="http://www.alpine.com/e/research/doc/">http://www.alpine.com/e/research/doc/</a>

[FI] Finnish	ALPS ALPINE EUROPE GmbH vakuuttaa, että radiolaitetyyppi ILX-705D/iLX-F905D/iLX-F115D/i905 on direktiivin 2014/53/EU mukainen. EU-vaatimustenmukaisuusvakuutuksen täysimittainen teksti on saatavilla seuraavassa internetosoitteessa: <a href="http://www.alpine.com/e/research/doc/">http://www.alpine.com/e/research/doc/</a>
[FR] French	Le soussigné, ALPS ALPINE EUROPE GmbH, déclare que l'équipement radioé lectrique du type ILX-705D/iLX-F905D/iLX-F115D/i905 est conforme à la directive 2014/53/UE. Le texte complet de la déclaration UE de conformité est disponible à l'adresse internet suivante: <a href="http://www.alpine.com/e/research/doc/">http://www.alpine.com/e/research/doc/</a>
[HR] Croatian	ALPS ALPINE EUROPE GmbH ovime izjavljuje da je radijska oprema tipa ILX-705D/iLX-F905D/iLX-F115D/i905 u skladu s Direktivom 2014/53/EU. Cjeloviti tekst EU izjave o skladnosti dostupan je na sljedećoj internetskoj adresi: <a href="http://www.alpine.com/e/research/doc/">http://www.alpine.com/e/research/doc/</a>
[HU] Hungarian	ALPS ALPINE EUROPE GmbH igazolja, hogy a ILX-705D/iLX-F905D/iLX-F115D/i905 típusú rádióberendezés megfelel a 2014/53/EU irányelvnek. Az EU-megfelelőségi nyilatkozat teljes szövege elérhető a következő internetes címen: <a href="http://www.alpine.com/e/research/doc/">http://www.alpine.com/e/research/doc/</a>
[IS] Icelandic	Hér, ALPS ALPINE EUROPE GmbH lýsir yfir að radióbúnaður tegund ILX-705D/iLX-F905D/iLX-F115D/i905 er í samræmi við tilskipun 2014/53/ESB. The fullur texti af ESB-samræmisýfirlýsing er í boði á eftirfarandi veffangi: <a href="http://www.alpine.com/e/research/doc/">http://www.alpine.com/e/research/doc/</a>
[IT] Italian	Il fabbricante, ALPS ALPINE EUROPE GmbH, dichiara che il tipo di apparecchiatura radio ILX-705D/iLX-F905D/iLX-F115D/i905 è conforme alla direttiva 2014/53/UE. Il testo completo della dichiarazione di conformità UE è disponibile al seguente indirizzo Internet: <a href="http://www.alpine.com/e/research/doc/">http://www.alpine.com/e/research/doc/</a>
[LT] Lithuanian	Aš, ALPS ALPINE EUROPE GmbH, patvirtinu, kad radijo įrenginių tipas ILX-705D/iLX-F905D/iLX-F115D/i905 atitinka Direktyvą 2014/53/ES. Visas ES atitikties deklaracijos tekstas prieinamas šiuo interneto adresu: <a href="http://www.alpine.com/e/research/doc/">http://www.alpine.com/e/research/doc/</a>
[LV] Latvian	Ar šo ALPS ALPINE EUROPE GmbH deklarē, ka radioiekārta ILX-705D/iLX-F905D/iLX-F115D/i905 atbilst Direktīvai 2014/53/ES. Pilns ES atbilstības deklarācijas teksts ir pieejams šādā interneta vietnē: <a href="http://www.alpine.com/e/research/doc/">http://www.alpine.com/e/research/doc/</a>
[MT] Maltese	B'dan, ALPS ALPINE EUROPE GmbH, niddikjara li dan it-tip ta' tagħmir tar-radju ILX-705D/iLX-F905D/iLX-F115D/i905 huwa konformi mad-Direttiva 2014/53/UE. It-test kollu tad-dikjarazzjoni ta' konformità tal-UE huwa disponibbli f'dan l-indirizz tal-Internet li ġej: <a href="http://www.alpine.com/e/research/doc/">http://www.alpine.com/e/research/doc/</a>
[NL] Dutch	Hierbij verklaar ik, ALPS ALPINE EUROPE GmbH, dat het type radioapparatuur ILX-705D/iLX-F905D/iLX-F115D/i905 conform is met Richtlijn 2014/53/EU. De volledige tekst van de EU-conformiteitsverklaring kan worden geraadpleegd op het volgende internetadres: <a href="http://www.alpine.com/e/research/doc/">http://www.alpine.com/e/research/doc/</a>
[NO] Norwegian	Herved ALPS ALPINE EUROPE GmbH erklærer at radioutstyr type ILX-705D/iLX-F905D/iLX-F115D/i905 er i samsvar med direktiv 2014/53/EU. Den fullstendige teksten i EU-erklæring er tilgjengelig på følgende internetadresse: <a href="http://www.alpine.com/e/research/doc/">http://www.alpine.com/e/research/doc/</a>
[PL] Polish	ALPS ALPINE EUROPE GmbH niniejszym oświadcza, że typ urządzenia radiowego ILX-705D/iLX-F905D/iLX-F115D/i905 jest zgodny z dyrektywą 2014/53/UE. Pełny tekst deklaracji zgodności UE jest dostępny pod następującym adresem internetowym: <a href="http://www.alpine.com/e/research/doc/">http://www.alpine.com/e/research/doc/</a>

[PT] Portuguese	O(a) abaixo assinado(a) ALPS ALPINE EUROPE GmbH declara que o presente tipo de equipamento de rádio ILX-705D/iLX-F905D/iLX-F115D/i905 está em conformidade com a Diretiva 2014/53/UE. O texto integral da declaração de conformidade está disponível no seguinte endereço de Internet: <a href="http://www.alpine.com/e/research/doc/">http://www.alpine.com/e/research/doc/</a>
[RO] Romanian	Prin prezenta, ALPS ALPINE EUROPE GmbH declară că tipul de echipamente radio ILX-705D/iLX-F905D/iLX-F115D/i905 este în conformitate cu Directiva 2014/53/UE. Textul integral al declarației UE de conformitate este disponibil la următoarea adresă internet: <a href="http://www.alpine.com/e/research/doc/">http://www.alpine.com/e/research/doc/</a>
[SK] Slovak	ALPS ALPINE EUROPE GmbH týmto vyhlasuje, že rádiové zariadenie typu ILX-705D/iLX-F905D/iLX-F115D/i905 je v súlade so smernicou 2014/53/EÚ. Úplné EÚ vyhlásenie o zhode je k dispozícii na tejto internetovej adrese: <a href="http://www.alpine.com/e/research/doc/">http://www.alpine.com/e/research/doc/</a>
[SL] Slovenian	ALPS ALPINE EUROPE GmbH potrjuje, da je tip radijske opreme ILX-705D/iLX-F905D/iLX-F115D/i905 skladen z Direktivo 2014/53/EU. Celotno besedilo izjave EU o skladnosti je na voljo na naslednjem spletnem naslovu: <a href="http://www.alpine.com/e/research/doc/">http://www.alpine.com/e/research/doc/</a>
[SV] Swedish	Härmed försäkrar ALPS ALPINE EUROPE GmbH att denna typ av radioutrustning ILX-705D/iLX-F905D/iLX-F115D/i905 överensstämmer med direktiv 2014/53/EU. Den fullständiga texten till EU-försäkran om överensstämmelse finns på följande webbadress: <a href="http://www.alpine.com/e/research/doc/">http://www.alpine.com/e/research/doc/</a>
[TR] Turkey	İşbu beyanla, ALPS ALPINE EUROPE GmbH radyo ekipmanı tipinin ILX-705D/iLX-F905D/iLX-F115D/i905, Directive 2014/53/EU yönergesine uyduğunu ilan eder. EU uyumluluk ilanının tam metnine (Declaration of Conformity) aşağıdaki internet adresinden ulaşılabilir. <a href="http://www.alpine.com/e/research/doc/">http://www.alpine.com/e/research/doc/</a>



### ENGLISH

#### **Information on Disposal of Old Electrical and Electronic Equipment and Battery (applicable for countries that have adopted separate waste collection systems)**

If you want to dispose this product, do not mix it with general household waste. There is a separate collection system for used electronic products in accordance with legislation that requires proper treatment, recovery and recycling. Contact your local authority for details in locating a recycle facility nearest to you. Proper recycling and waste disposal will help conserve resources whilst preventing detrimental effects on our health and the environment.

### DEUTSCH

#### **Informationen zur Entsorgung von Elektro- und Elektronikgeräten und Batterien (anwendbar für Länder, die ein separates Sammelsystem übernommen haben)**

Wenn Sie dieses Produkt entsorgen wollen, entsorgen Sie dies nicht über den normalen Hausmüll. Es gibt ein separates Sammelsystem für gebrauchte elektronische Geräte in Einklang mit den Rechtsvorschriften, die eine angemessene Behandlung, Verwertung und Recycling erfordert. Kontaktieren Sie Ihre lokale Behörde für Details bei der Suche nach einer Recycling-Anlage Ihrer Nähe. Ordnungsgemäße Verwertung und Entsorgung trägt dazu bei, Ressourcen zu schonen und schädliche Auswirkungen auf unsere Gesundheit und die Umwelt zu verhindern.

### FRANÇAIS

#### **Information sur le traitement des Déchets Electriques et Electroniques (DEEE), pour les pays ayant adoptés un traitement séparés de ces déchets**

Si vous possédez des appareils Electriques ou Electroniques usagés, ne les jetez pas dans le système général. Conformément à la Directive Européenne, transposée dans votre pays, il existe un système séparé de recyclage et de traitement de ces déchets. Veuillez contacter l'administration locale afin de prendre connaissance du lieu de recyclage et de traitement le plus proche de chez vous. Ce système est destiné à protéger l'environnement.

### ESPAÑOL

#### **Información sobre la eliminación de Viejos Equipos Eléctricos y Electrónicos, así como Baterías (aplicable en los países que han adoptado sistemas de recogida selectiva de residuos)**

Si desea deshacerse de este producto, no lo mezcle con los residuos generales de su hogar. Existe un sistema de recogida selectiva para aparatos electrónicos usados de acuerdo a la legislación, que requiere un tratamiento adecuado de recuperación y reciclado. Póngase en contacto con las autoridades locales para obtener más información sobre el punto de recogida y tratamiento más cercano. El apropiado reciclado y eliminación de residuos ayuda a conservar los recursos y a contribuir en la prevención de los efectos negativos y perjudiciales sobre nuestra salud y el medio ambiente.



**ALPINE ELECTRONICS OF AMERICA, INC.**

1500 Atlantic Blvd,  
Auburn Hills, Michigan 48326, U.S.A.  
Phone 1-800-ALPINE-1 (1-800-257-4631)

**ALPINE ELECTRONICS OF AUSTRALIA PTY. LIMITED**

161-165 Princes Highway,  
Hallam Victoria 3803, Australia  
Phone 03-8787-1200

**ALPS ALPINE EUROPE GmbH**

Ohmstrasse 4, 85716 Unterschleissheim, Germany  
Phone: +49 (0) 89-32 42 640

For contact information on your respective country,  
please visit [www.alpine-europe.com](http://www.alpine-europe.com).

**ALPS ALPINE EUROPE GmbH**

Aurora House, Deltic Avenue  
Rooksley, Milton Keynes, MK13 8LW  
United Kingdom  
Phone: 0345-313-1640

**ALPS ALPINE ASIA CO., LTD.**

The 9th Towers, Tower B, 24th Floor, Unit TNB01-03,  
33/4 Rama 9 road, Huay Kwang, Bangkok, 10310, Thailand  
Phone +66 (2) 090 9596

YAMAGATA THAILAND HQ

324 Moo 4, Bangpoo Industrial Estate Soi 6B,  
Sukhumvit Road, T.Prasa, A.Muang Samutprakarn,  
Samutprakarn 10280

Designed by ALPS ALPINE Japan  
Printed in Thailand  
68-41657Z79-A (Y\_A5)